

If you need this information to be provided to you
in Braille or Large Print please contact
Handicap International at 0813 6072 4304
or at the contact information provided below

DISABILITY CHECKLIST FOR EMERGENCY RESPONSE

Adapted from Disability Task Force

**HANDICAP
INTERNATIONAL**

- 1 General Guidelines
- 2 Health and Nutrition
- 3 Water and Sanitation
- 4 Protection, Women and Children with Disabilities
- 5 Reconstruction and Shelter
- 6 Livelihoods
- 7 Education

For Further Information:

Handicap International
Jl. Magelang Karang Waru Kidul TR II/22A
Tegalrejo, Yogyakarta 55241
(62) (0274) 556478
(62) 0813 6072 4304
hiindo_reliefliaison@yahoo.fr



This booklet is printed with
The Financial Support of DFID

*General protections and inclusion principles
of injured persons and people with disabilities*



General Guidelines

General Guidelines for the protection and inclusion of injured persons and people with disabilities

- * Ensure **non-discrimination** when providing emergency assistance, and **promote inclusion of all vulnerable groups** including women, children, **injured persons**, senior citizens and **people with disabilities**.

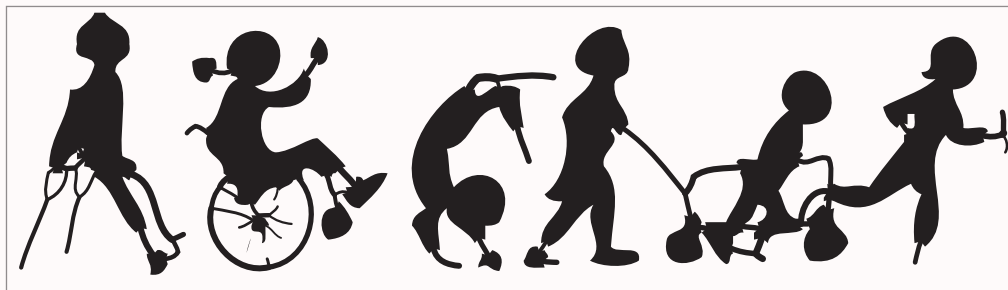

Copyright © 1987 Hesperian Foundation, by David Werner

- * Make special efforts to **identify, locate, register, and follow-up with** people with disabilities and other vulnerable groups. Sometimes people from these groups are harder to find or make contact with **but they have the same needs as everyone else**.
- * **Include specific questions** about disability issues in all of your **assessments**; make sure that data can be used for interventions and focuses on the **specific obstacles faced** by people with disabilities and **identifies their specific needs**.
- * **Consult** people with disabilities and encourage their participation in **decision-making** and **planning** for disaster response. Take into account the needs of this group when designing both immediate and long term responses. They can tell us their needs much better than we can assess them.
- * **Ensure** that people with disabilities and other vulnerable groups can **access information** you are providing. For example sometimes information booklets will be of no use to a person with visual impairments, and information broadcasted on loud speakers will not reach those who cannot hear.
- * **Raise awareness** and talk about both the **specific** and **basic needs** of people with injuries and disabilities and other vulnerable groups when discussing these issues with the government, military, law enforcement personnel, and humanitarian workers.

Health & Nutrition

Ability to get appropriate and timely medical attention with proper follow-up is of primary concern especially to ensure that people injured during the earthquake heal properly and do not sustain permanent impairments because of their temporary

* *The following considerations should be taken into account when considering health and nutrition related responses:*

- 1 **Record** system of health services including disability specific information
- 2 **Collate** a list of services that can be provided to people with disabilities and injuries
- 3 **Ensure** that all health staff know the different and specialized services available
- 4 **Build** up a clear referral system to the specialized services within the institution and with other health service providers
- 5 **Orient** health staff on the specific needs of injured / disabled people and how to address them
- 6 **Follow-up** with patients to ensure that once they have been discharged from the health facility, they are recovering well and their health needs are continuing to be met



Copyright © Handicap International



Copyright © Handicap International

injuries. Earthquake victims may not be able to access medical help because of many reasons including lack of awareness of available health infrastructures, inability to transport themselves or lack of financial means etc.

* *Provide supportive / assistive devices and training on how to use these (e.g. crutches, wheelchairs, hearing aids, prosthetics, eyeglasses). Through early intervention the severity of the functional impairment can be minimized and the functional ability of the person with disabilities or injury can be maximised.*

This can be done by developing a comprehensive assistive device provision system

- 1 **Evaluate** Needs
- 2 **Provide** or adapt the assistive device according to the individual's needs and situation
- 3 **Ensure** the individual and their family knows how to use the assistive device you are providing
- 4 **Know** about specific services and referral systems that can also provide holistic support to the individual

* *Provide specialized health services and medical care for injured / disabled people and ensure these services are accessible*

- 1 **Ensure prevention of disability or deterioration of impairment** by providing appropriate drugs (for diabetes, hypertension, epilepsy etc)
- 2 **Refer** the individual to rehabilitation services when appropriate / possible to avoid worsening the impact of the impairment or injury
- 3 **Train** staff on appropriate responses to disabled / injured person to avoid worsening the disability
- 4 **Provide** the individual with specific equipment (e.g. catheter for SCI on a sustainable basis). When you cannot sustain, ensure that the person is referred to these services.

Nutrition issues for people with disabilities and injuries

People with disabilities and injuries may not have access to the same health services, food distributions etc, even though they have the same, if not additional needs as others. This can be due to various reasons including lack of mobility to reach food

* *Consider the nutritional risks for disabled / injured persons through supplementary feeding program for children and additional ration for adults*

Food and Utensil distribution and privacy

- 1 People who are injured or disabled may not be able to come to food / water / utensil distribution sites. Monitor the rate at which people with disabilities / injuries are receiving these supplies and take additional measures to reach injured / disabled individuals in their homes or temporary shelters.
- 2 Some children with disability may have difficulties using usual utensils to eat and may need spoons, straws, etc to ensure proper intake of food
- 3 When possible **ensure space to eat in privacy** for people who need assistance or eat with difficulties.

Specific diets

- 1 Injured / disabled people may need **additional high energy food** to ensure their well being
- 2 Injured / disabled people may need **specific diets** to ease healing process, ensure well being and prevent complications. For example some people may not be able to swallow solid foods and may need special liquid-based supplements.
- 3 **Make sure** that injured / disabled people have family members or **extra assistance** to help them in eating when it is necessary.
- 4 **Monitor** the nutritional status of people injured / with disability

distribution site, did not hear or see communication messages. (For example if a person has a visual impairment they will not be able to read a pamphlet informing them of where or when they can get medical assistance or access to food distributions.

* *Communication of the health prevention messages may be not understood by injured / disabled people*



Copyright © David Werner

Communication accessibility

- 1 **Ensure** all documentation related with preventive / promotive health is **accessible** to visually, hearing, mental disability using appropriate communication means (e.g. large print, Braille, using loudspeakers / radio announcements etc)
- 2 **Be aware** that injured / disabled people may not be able to move from their houses and may miss your service messages if you are using a “blanket coverage” method. Find other ways (home delivery etc) to make sure everybody has access to your message
- 3 **Ensure** that the existing health services are well signaled so injured / disabled people and their families know where to find support.
- 4 **Orient / Sensitize** your staff so that they have a certain level of understanding about disability.

Water & Sanitation

Access to water and sanitation facilities are basic needs of all people with injuries and disabilities. Access to WatSan facilities should be promoted through physical accessibility as well as a positive attitude towards encouraging people with injuries / disabilities to use these accessible facilities.

* *Additional measures may be needed to ensure that access to water is equitable.*

Accessibility of water points / water distribution

- 1 **Ensure** that some of the water points / water distribution places are accessible for people with low mobility or using mobility aids.
- 2 **Prioritise** injured and disabled people with injury / with disability through a special queue to avoid long standing wait.
- 3 **Provide** assistance for people with disabilities / injuries to carry empty containers and full water containers to their homes if they cannot do so themselves.

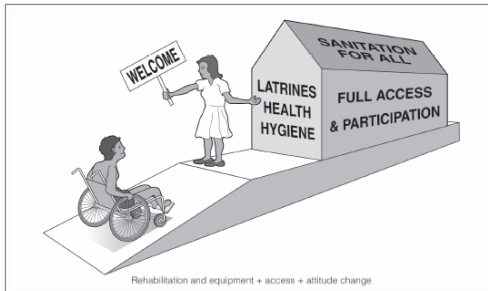

Copyright © 2005 Hazel Jones, WEDC Loughborough University

Communication

- 1 **Ensure** that people with injury/disability know where and when water will be distributed using different means of information (posters, loudspeakers etc).
- 2 **Ensure** that people with injury / disability understand prevention messages or information related to water **using appropriate communication channels** for example for visually impaired (verbal communication or Braille), hearing impaired (Written material, Symbols or Sign Language), mentally impaired people (Simple language and drawings).
- 3 Water distribution system should be **accessible** and **safe** for people with injury / disability.

Water pump design should take into consideration ability of people with disability to use them

- 1 **Extend** the hand of the water pump
- 2 **Non slippery** pump platform and **good evacuation system**
- 3 Water pump should be located in a **safe location** close to disabled people home

Water containers

- 1 **Specific** water containers should be designed to suit the ability of person with injury / disability (wheelchair users, mobility aids users, children, etc;)
- 2 **Develop** a social network to support people with injury/disability to access water
- 3 **Monitor** the access of water by people with injury / disability
- 4 **Make** sure that your staff and the community are aware of the specific needs of people with injury/ disability through awareness and sensitisation focus group

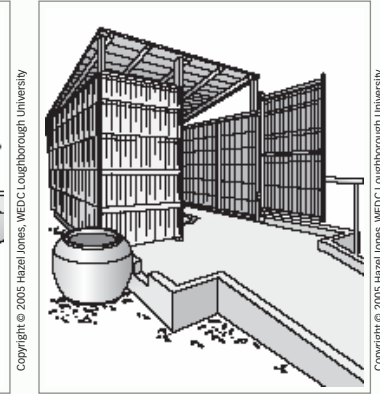
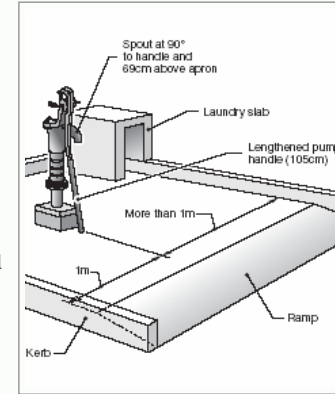

Copyright © 2005 Hazel Jones, WEDC Loughborough University

Copyright © 2005 Hazel Jones, WEDC Loughborough University

* *Toilets should be designed and built in such a way that they can be used by all sections of the population, including people with disabilities.*

Have a percentage of latrines accessible and safely located

- 1 Ramp at the entrance (1:10 slope, handrails)
- 2 Latrine seats 0.45 m and 0.50 m from the finished floor level.
- 3 Handrails on either side at an appropriate height
- 4 Enough space to turn a wheelchair (circle of 90 cm diameter)
- 5 Large doors to allow a wheelchair to enter the facility (80 cm)

Protection

* *People with injuries / disabilities are especially vulnerable to physical, sexual and emotional abuse and may require additional protection considerations*

* *Establish monitoring and complaints investigation mechanisms to redress violations of the rights of the disabled*

* *Ensure psycho-social support initiatives*

Proximity and accessibility to existing facilities

- 1 Location of family with injured / disabled people should be **close to the existing facilities**
- 2 Some **“safe” areas** should be considered with extra staff to free family members / care givers to access relief activities
- 3 Volunteers from the local community should be **identified and trained** to assist people with injuries / disabilities and their family
- 4 **Appropriate** communication means and channels should be developed to ensure that people with injuries/ disabilities have access to all information (visually, hearing, mentally disabled)

Monitoring access to relief activities

- 1 **Registration** of people with injury / disability and identification through a special ID card (distribution, information dissemination, etc.)
- 2 **Record** of assistance received



Copyright © Handicap International

Protection against emotional abuses

- 1 **Peer counseling** (note that injured / disabled people may feel more comfortable sharing with someone who has experienced injury / lives with a disability)
- 2 Establishment or re-establishment of **support networks**
- 3 Awareness of staff and local community about people with injury / disability special needs and situation
- 4 **Women with disabilities are doubly vulnerable.** In many cases women with disabilities have even fewer opportunities to access relief and support than men with disabilities, this may be due to over-protectiveness of families, low self-confidence, lack of mobility aids and appliances and many other obstacles. **Ensure** wherever possible that injured / disabled women are part of the community support network and they are included in vulnerability assessments.

Encourage their participation in all relief / reconstruction decision-making process.

- 5 **Children with disabilities are extremely vulnerable.** Children with Disabilities are prone to exploitation, violence and abuse just as other children are. However they face additional obstacles such as isolation, lack of confidence and communication barriers which makes it more difficult for them to seek support. **Ensure** children with disabilities are included in all vulnerability assessments and **include them** in children-friendly spaces and back to school programs.

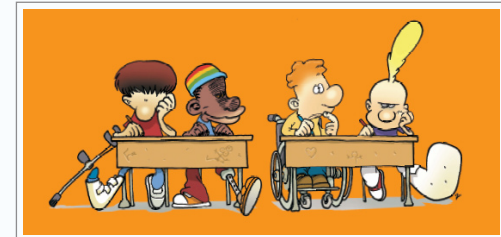

Copyright © 2005 TOOTUFF by Zep

Reconstruction & Shelter

* *Include Persons with Disabilities in reconstruction plans so as to improve access to shelters, schools, community health centres and other public buildings*

Depending on the type of building, the cost of providing accessibility for people with disabilities can be as low as 0.5 - 1% of the total cost of a project.

Involvement of people with disability (all types of disability)

- 1 **Involve** people with disability in participatory reconstruction planning and monitor that they are present at planning sessions
- 2 **Use the expertise** of people with disabilities for planning and implementing accessible reconstruction
- 3 **Ensure** people with disabilities participate in decision making for the reconstruction planning



Copyright © 2005 Handicap International

* *By including Persons with Disabilities in Barrier Free reconstruction plans, disabilities can be prevented and the impact of impairments minimised*

Reconstruction norms

- 1 **Use universal design** to plan as minimum standards of accessibility
- 2 **Build adapted houses / shelter** for people with disability in order to address their specific needs or provide assistance to people with disabilities and their families who are building their own shelters.

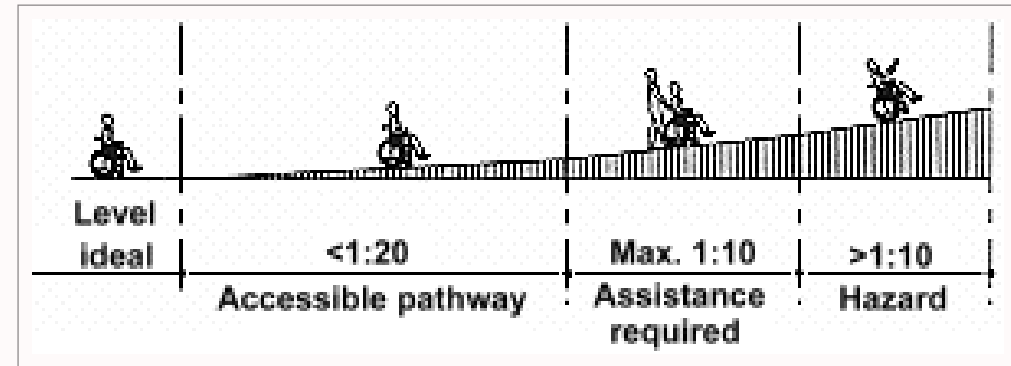

Copyright © UN Accessibility Design Manual

Livelihoods

Injured and disabled people have the same livelihood needs as everyone else

By contributing to the family income people with disabilities can reduce their economic reliance on their family (and reduce the perception that disabled people are burdens on their family) and the family can begin recovering from the economic effects of the disaster as soon as possible.

- 1 **Include** people with disabilities/injuries and their families in livelihood assessments
- 2 **Provide** people with disabilities/injuries with the means (tools, equipment etc) to recover their livelihoods
- 3 **Ensure** that vocational training, micro-credit schemes and other livelihood enhancement opportunities include people with disabilities
- 4 **Adapt** if necessary livelihood tools and equipment to suit the needs of the individual. (Most often the individual will be able to tell you how the equipment can be adapted so that they can use it fully)
- 5 **Ensure** that people with injuries/disabilities understand are receiving information on vocational training opportunities/tool and equipment distribution etc by **using appropriate communication channels** for example for visually impaired (verbal communication or Braille), hearing impaired (Written material, Symbols or Sign Language), people with low literacy/language difficulties (Simple language and drawings).



Photo by Dewi Adyanti Satriyani

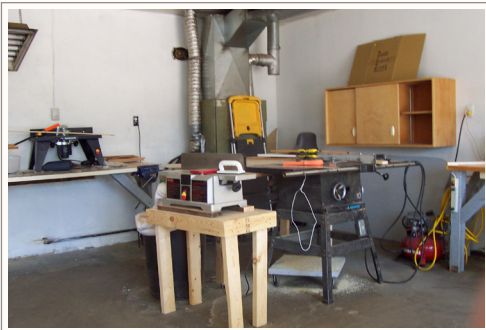

Copyright © 2005 Woodworkers with Disabilities



Copyright © 2005 Handicap International

Education

Efforts should be made to ensure that that 'all' children in every village start / re-start / continue going to school.

While re/constructing the school premises among other things please keep the following things in mind.

The school buildings

- 1 Ensure that the steps are of low height (preferably 4") and are wide, deep and not steep so that as to allow a child with appliances to safely use them.
- 2 Handrails on either side at an appropriate height for the children.
- 3 A ramp to help children who have difficulty using stairs, particularly those who use a wheelchair (inclination minimum 1:10).
- 4 Doors are wide enough to allow entry of children using mobility appliances such as wheelchairs (at least 80 cm).
- 5 Floors are non slippery and there are no barriers on the floor.



Copyright © 2004 Varnos Adeline

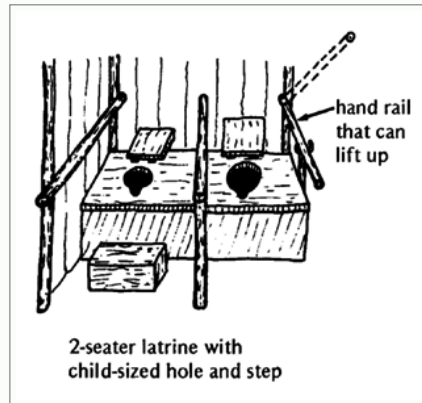

Copyright © David Wiener

The toilets

- 1 Ensure that the steps are of low height (preferably 4") and are wide enough.
- 2 The steps should be wide, deep and not steep so as to allow a child with appliances to safely use them.
- 3 Handrails on either side at an appropriate height for the children.
- 4 A ramp to help children who have difficulty using stairs, particularly those who use a wheelchair (inclination minimum 1:10).
- 5 Doors are wide enough to allow entry of children using mobility appliances such as wheelchairs (at least 80 cm).
- 6 Floors are non slippery and there are no barriers on the floor.
- 7 Enough space inside to move around with appliances (circle of 90m diameter).
- 8 Water source accessible and usable by ALL.
- 9 No stagnation of water around.

Drinking water facility

- 1 The tank is situated within an appropriate distance.
- 2 The height of the tap is such that ALL children can use it.
- 3 The tap is such that ALL children find it easy to operate them.
- 4 Hand rails / rails to facilitate movements of those in need.
- 5 Non-slippery floor.
- 6 No stagnation of water around.

Preparedness – Include the needs of people with disabilities into future disaster preparedness planning.

- 1 Registration of people with disability / special needs
- 2 Train people with disability / special needs on adequate evacuation/ protection measures using appropriate communication means.
- 3 Support the development of a social network as a preventive measure